



Trangia®

Made in Sweden  Since 1925

Trangia
Made in Sweden

Caution: Never use the burner with
the flame in complete extinguish
and the burner has cooled down
before use in order to avoid accidents
Use only in a well-ventilated
area and do not use in enclosed
spaces. Full safety instructions
are on the back of the burner.

Warning: Use the stove outdoors. Use lighters or
any "flameless" burner is highly inflammable and
attention: the compressed gas can explode and
may become a fire hazard. Use only in a well-ventilated
area and do not use in enclosed spaces. Use only
in a well-ventilated area and do not use in enclosed
spaces. Full safety instructions are on the back of the
burner. 3073

The Handbook

Content

Customer service and contact	4-5
Quick guide – Illustrations	6-7
Quick guide – English 	8-9
Snabbguide – Svenska 	10-11
Kurzanleitung – Deutsch 	12-13
Maintenance and care	14-17
Indoor use – your back up stove	18-19
Spirit burner and fuel	20-21
Gas burner and fuel	22-23
Multifuel burner and fuel	24-25
Gel burner and fuel	26-27
Stove dimensions	28-29
Using the Preheater FV21	30-31

Hello and thank you for joining us!

WE HOPE YOU WILL enjoy your new Trangia product and that you already have some outdoor adventures planned. We love seeing our stoves in use so please tag us in your photos! If you have any questions for our great customer support team or just want to say hello, don't hesitate to contact us!

See you out there!

THE TEAM AT TRANGIA



Contact us!



Customer Support

For questions or help with your Trangia products please contact our support team:

Email: customersupport@trangia.se

Phone: +46 (0)640- 681335

Follow us on Social media

 [@trangia_sweden](https://www.instagram.com/trangia_sweden)  [@trangia.sweden](https://www.facebook.com/trangia.sweden)

Tag us

[#trangia_sweden](https://www.instagram.com/explore/tags/trangia_sweden) [#trangia_moment](https://www.instagram.com/explore/tags/trangia_moment)

Web

Website:

www.trangia.se

Webshop:

www.shop.trangia.se

Visit us!

YOU WILL FIND OUR brand store with highly qualified staff and a complete range of Trangia products directly from the factory. Right by the E14 highway in the village Trångsviken in Jämtland.

Factory Store and Museum

Alsenvägen 12
83596 Trångsviken
Sweden
+46 (0)640-681335

Head office and factory

Trangia AB
Alsenvägen 16
83596 Trångsviken
Sweden
+46 (0)640-681330
info@trangia.se



Quick Guide

– How to use your stove

1

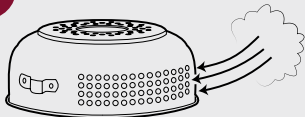

2

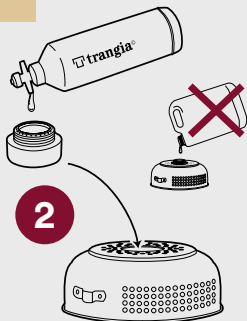

5

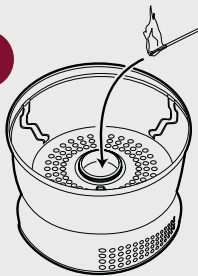

6

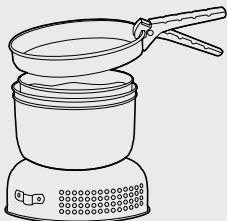

3

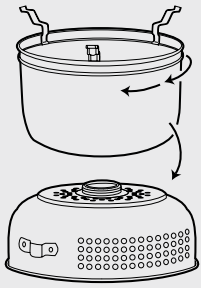

4

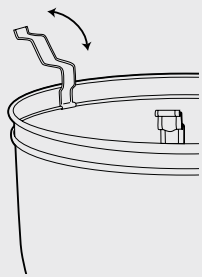

7

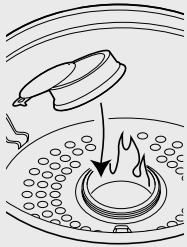

8

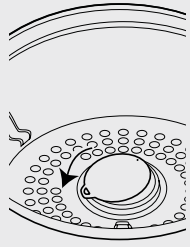

Quick Guide

– How to use your stove

- 1 PLACE THE LOWER WINDSHIELD** on a flat piece of ground, away from flammable materials and sheltered from the wind as much as possible. Position the air holes so they are facing the wind.
- 2 FILL THE SPIRIT BURNER** (max 2/3 full, approx. 100 ml) and place it in the lower windshield.
- 3 POSITION THE UPPER** windshield on the lower windshield and turn to fasten into place.
- 4 FLIP ALL THE HOOKS** down to use a saucepan or kettle, and flip them up to use the frypan.
- 5 LIGHT THE FUEL** in the burner and place the pan you are using on the stove.

- 6 USE THE FRYPAN** as a pot lid in upright position for more efficient cooking.
- 7 PLACE THE SIMMER** ring with open lid on the burner and regulate the flame with the brown lid.
- 8 TO EXTINGUISH** the flame, close the lid on the simmer ring.



IMPORTANT: If the fuel burns out before you have finished cooking, wait until the burner is cold (so you can comfortably hold it with your bare hands) before refilling it. Never leave the stove unattended. Adjust the position of the stove if the wind changes direction.

Snabbguide

– så använder du köket

- 1 STÄLL DET UNDRE** vindskyddet på plan mark, utan närhet till brännbart material och så vindskyddat som möjligt. Vänd hålen i vindskyddet mot vinden.
- 2 FYLL SPRITBRÄNNAREN** med bränsle, maximalt $\frac{2}{3}$ av dess höjd (ca 100 ml). Placera brännaren i det nedre vindskyddet.
- 3 SÄTT DET ÖVRE** vindskyddet på det undre, och vrid för att de ska sitta ihop.
- 4 FÄLL NER HAKARNA** för att använda en kastrull eller kaffepanna och fäll upp dem för att använda stekpannan.
- 5 TÄND BRÄNSLET** i brännaren och placera kastrullen med mat/vatten i köket.

- 6 ANVÄND STEKPANNAN** som lock i rättvänt läge för snabbare och bränsleeffektiva matlagning.
- 7 REGLERA LÅGAN** genom att placera sparringen med öppet lock på brännaren och reglera lågan med det bruna locket.
- 8 FÖR ATT SLÄCKA** lågan, stäng locket på sparringen helt.



VIKTIGT: Om bränslet tar slut innan du är färdig med matlagningen måste du vänta till brännaren är kall (så pass att du kan hålla den med dina bara händer) Lämna aldrig det tända köket utan uppsikt. Om vinden ändrar riktning: vrid köket försiktigt så att hålen pekar mot vinden.

Kurzanleitung

– so benutzen Sie Ihren Kocher

- 1 STELLEN SIE DEN UNTEREN** Windschutz auf einen ebenen Untergrund, außerhalb der Reichweite von brennbaren Materialien und so windgeschützt wie möglich. Drehen Sie den Windschutz so, dass die Luftlöcher dem Wind zugewandt sind.
- 2 FÜLLEN SIE DEN SPIRITUSBRENNER** zu maximal $2/3$ (ca. 100 ml) seiner Höhe mit Brennstoff. Setzen Sie den Brenner in den unteren Windschutz.
- 3 SETZEN SIE** den oberen Windschutz auf den unteren und schrauben Sie ihn fest.
- 4 DIE DREI HAKEN** am oberen Windschutz klappen Sie zur Verwendung mit Kochtöpfen nach unten, mit Bratpfannen nach oben.
- 5 ZÜNDEN SIE DEN BRENNSTOFF** an und setzen Sie den gefüllten Kochtopf in den Kocher.

6 NUTZEN SIE DIE BRATPFANNE als Deckel für den Kochtopf, um die Kochzeit zu verkürzen.

7 SETZEN SIE den Regulier- und Lösch-Aufsatz geöffnet auf den Brenner, um die Kochstärke zu reduzieren. Um die Flamme noch weiter zu drosseln, schieben Sie den braunen Deckel etwas weiter über die Öffnung des Ringes.

8 UM DIE FLAMME GANZ zu löschen, schieben Sie den Deckel vollständig über die Öffnung des Regulier- und Lösch-Aufsatzes.



WICHTIG: Wenn der Brennstoff ausgeht, bevor Sie mit dem Kochen fertig sind, müssen Sie warten bis der Brenner so weit abgekühlt ist, dass Sie ihn problemlos anfassen können bevor Sie ihn neu befüllen. Lassen Sie den Kocher während der Nutzung niemals unbeaufsichtigt. Wenn sich die Windrichtung ändert: drehen Sie den Kocher vorsichtig, sodass die Luftlöcher wieder dem Wind zugewandt sind.

Maintenance and care

WE HAVE PUT TOGETHER some instructions for you to ensure safe trouble-free outdoor cooking and a long life for your stove. You can also find instructions and videos on our Youtube channel and website.



The spirit burner

Important notes



- **USE TRANGIA'S** fuel bottle that has a safety closure and easy-pour feature.
- **FILL THE BURNER** to a maximum of 2/3 full (approx. 100 ml).
- **EMPTY THE BURNER** when you have finished cooking. Do not store fuel in the burner.



- **ONLY USE** alcohol-based fuel – never petrol or other oil-based fuel.
- **NEVER REFILL** the burner with fuel before it is completely extinguished and has cooled down.
- **BE ABSOLUTELY 100%** sure the stove is not burning or still warm if pouring fuel back into the bottle.

Packing and storing

– the easy way

- **MAKE SURE THE BURNER** is completely empty of fuel to avoid the risk of leakage.
- **STORE THE BURNER** in the yellow plastic bag to avoid corrosion.
- **PROTECT NON-STICK PANS** with the protective plastic sheet or the Multidisc.
- **POSITION THE STRAP** buckle at the side of the stove.
- **STORE YOUR STOVE** in a Trangia cover bag.
- **THE FUEL BOTTLE** is best transported in an upright position, such as in the side pocket of a backpack.
- **MAKE SURE ALL PARTS** are clean and dry before packing them away for storage.

Cleaning and caring

– to ensure many years of use

- **DO NOT STORE FOOD** in the pots or pans – they should be washed directly after use.
- **WASH POTS AND PANS** and other parts with regular washing-up liquid and a brush/soft sponge.
- **IF YOU NEED A LITTLE EXTRA HELP:** use steel wool or Scotch-Brite (NOT on non-stick pans).
- **NEVER PUT POTS, pans** or other parts in your dishwasher – the chemicals used in dishwasher detergent destroy the aluminum's surface.
- **CLEAN THE OUTSIDE** of your pots and pans as well. If you are using gas there will be almost no need for this, but petrol or alcohol-based fuel is more likely to leave a sooty residue. This is easy to clean off, however.

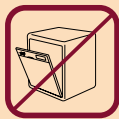

Using a Trangia stove indoors

CAMPING STOVES are designed for outdoor use. If you do need to use your stove indoors, for example during a power outage, please take note of the following:

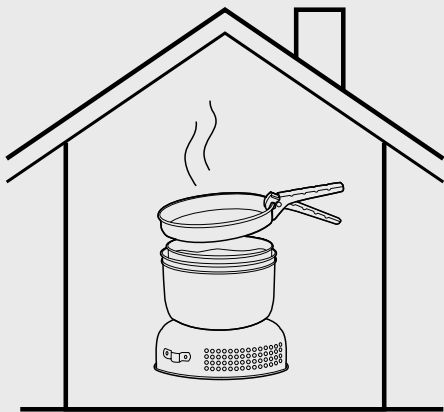

- **READ THE USER INSTRUCTIONS** carefully and make sure you know how to use it outdoors.
- **TEST USING YOUR STOVE** outdoors first and cook an entire meal, so that you know how everything works and how you should handle your burner and fuel.
- **MAKE SURE THE SPACE** you are in has good air circulation. Avoid small spaces with poor ventilation. In an apartment, it is enough to have a window ajar.
- **PLACE THE STOVE** on a fire-safe surface, such as a baking tray.
- **MAKE SURE THERE** is free space above and around the stove so that nothing can catch alight.
- **NEVER LEAVE** a lit stove unattended.
- **USE THE HANDLE** to position the supports and other parts once burner has been lit.



User instructions are available on our website **www.trangia.se**

Spirit Burner B25

SPIRIT BURNER FOR ALCOHOL-BASED FUELS. Easy to use due to its simple construction. The simmer ring regulates the heat and is used to save fuel or to extinguish the flame. Works in all weather conditions. The spirit burner is compatible with all Trangia stoves.

ONE FILLING (approx. 100 ml, max 2/3 full) will burn for approx. 25 minutes. In temperatures below 0°C, the Preheater can be used for increased efficiency and shorter cooking times.

MORE ABOUT THE Preheater FV 21 on page 30-31.



WEIGHT: 110 g.

FUEL: Alcohol based fuel
(such as Methylated or bioethanol spirits)

EFFECTIVE OUTPUT: 1000 W/3500 BTU.

BOILING TIME: Approx. 10 minutes for 1 litre of water.
This varies according to weather and quality of fuel.

Gas Burner GB 74

THE GAS BURNER is compatible with all Trangia stoves except the Mini Trangia. Fits all propane/butane gas containers with threaded valves that meet the international standard EN417. The gas burner is easy to use, has fast cooking times and keeps the pans soot free. For trouble-free use and advice on cleaning and care, read the instructions provided with the burner.

GAS CONSUMPTION: 150 g/h. A gas canister of 230g will burn 1.5 hrs on full power.



WEIGHT: 180 g.

FUEL: Butane/propane canister.

EFFECTIVE OUTPUT: 2100 W/6700 BTU.

BOILING TIME: Approx. 3.5 minutes for 1 liter of water.

Multifuel Burner X2

THIS BURNER IS A FAST alternative and especially suitable for extreme weather conditions. The multifuel burner only fits the Trangia stoves in series 25 and 27. Burns on liquid fuel and can also be used with gas. Fits all propane/butane gas containers with threaded valves that meet the international standard EN417.

WE OFFER A SPECIAL service kit (Art.no 750100) for our Multifuel burner. It contains the most important spare parts that can wear out or need to be changed. For trouble-free use and advice on cleaning and care, read the instructions provided with the burner.

CONSUMPTION: Gas 116g/h. Alkylated petrol 2dl/h.



WEIGHT: 525 g.

FUEL: Butane/propane canister or liquid fuel such as chemically clean petrol (alkylate petrol or Primus Powerfuel).

EFFECTIVE OUTPUT: 1500 W/5200 BTU (petrol).

BOILING TIME: Approx. 4.5 minutes for 1 litre of water.

Gel Burner B24

THE GEL BURNER IS A simpler type of burner and consists of a cup with lid that is used with gel or solid fuel. Suitable when traveling and you have simple cooking needs – for example, if you only need to boil water or if you want to avoid gas cartridges or liquid fuel.

THE GEL BURNER IS compatible with all Trangia stoves. Gel and tablets can also be used as fire starters for the campfire. The availability of these fuels varies depending on country.

A LIST OF FUELS and what they are named in different countries is available on our website:

www.trangia.se/en/fuel-list

OR SCAN THE QR CODE





WEIGHT: 18 g.

FUEL: Gel or solid fuel tablets.

EFFECTIVE OUTPUT: Varies widely depending on fuel used.

BOILING TIME: Approx. 7 minutes for 1 litre of water (gel).

Stove dimensions

25
LARGE

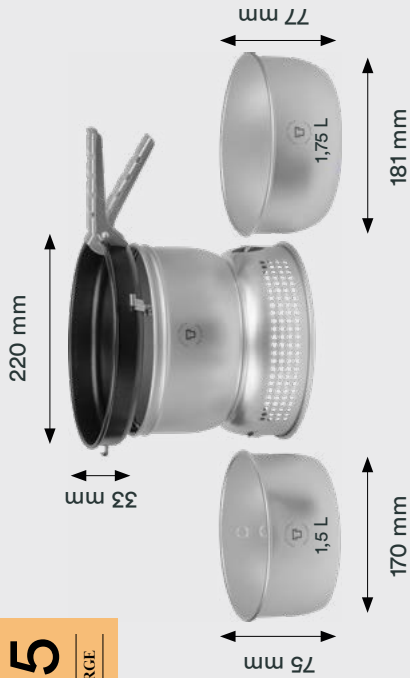

27

SMALL

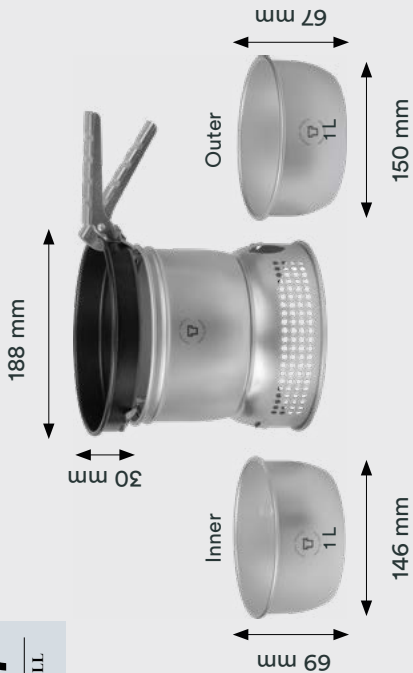

Using the preheater in winter conditions

IN COLD TEMPERATURES, you may need to preheat the spirit burner for optimum efficiency.

- **PUT A FEW DROPS** of fuel on the absorbent pad in the preheater and attach it to the base of the burner.
- **FILL THE BURNER** with fuel.
- **LIGHT THE FUEL** in the preheater and place it together with the burner in the lower part of the windshield.
- **LIGHT THE BURNER** and start cooking as usual.
- **THE FUEL IN THE** preheater will burn out after about two minutes.
- **THE FLAMES MAY BURN** higher than usual before the preheater burns out; keep an extra watchful eye on the stove during this time.

Watch our instruction videos on our Youtube channel.

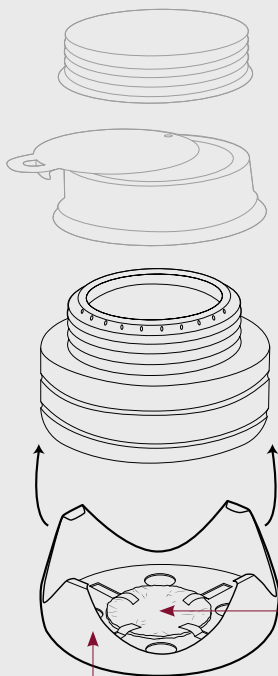

Absorbent pad

Preheater FV21

Love your
#trangia_moment



 **trangia**[®]

Made in Sweden  Since 1925