

1

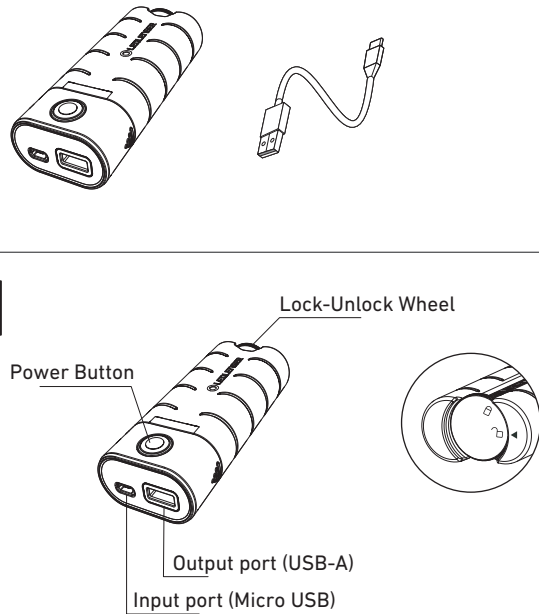

2

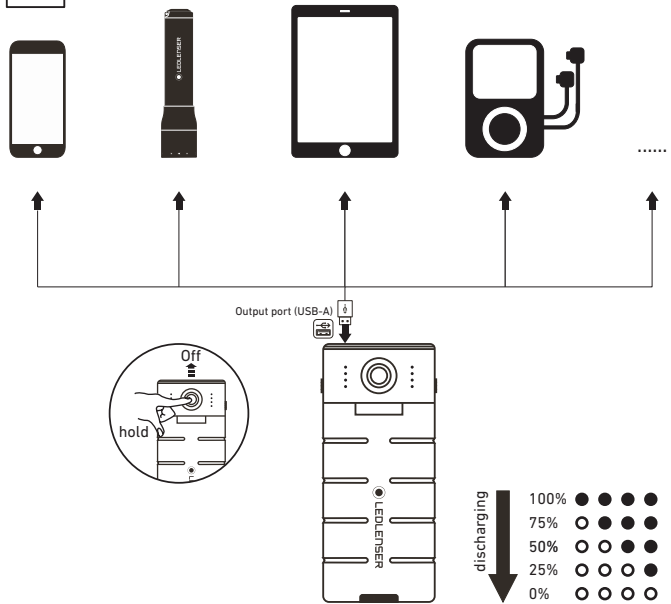

3

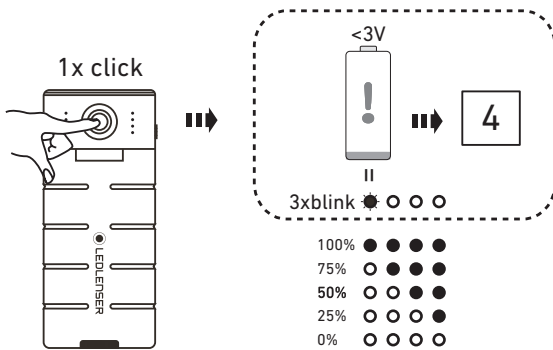

4

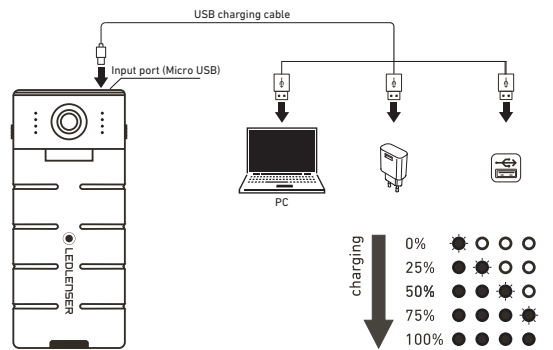

5

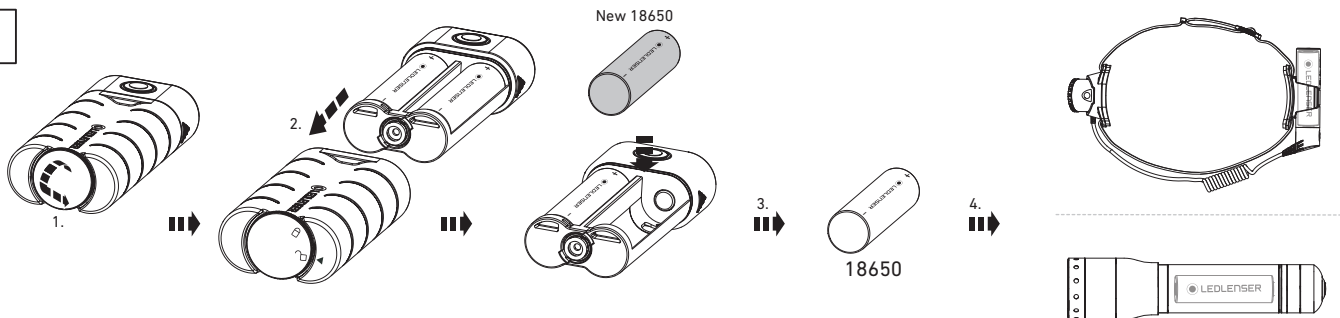

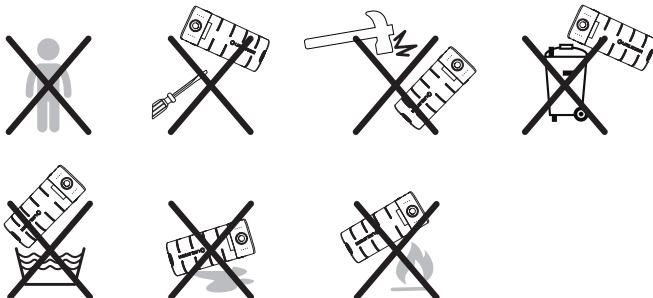
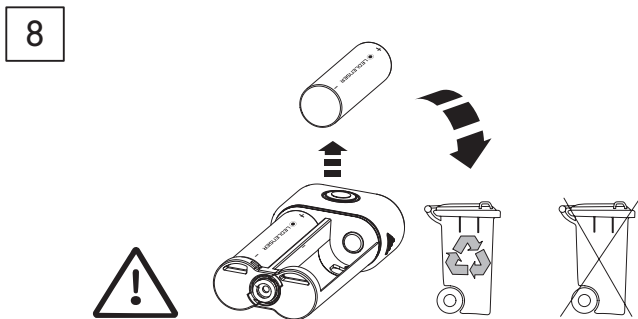
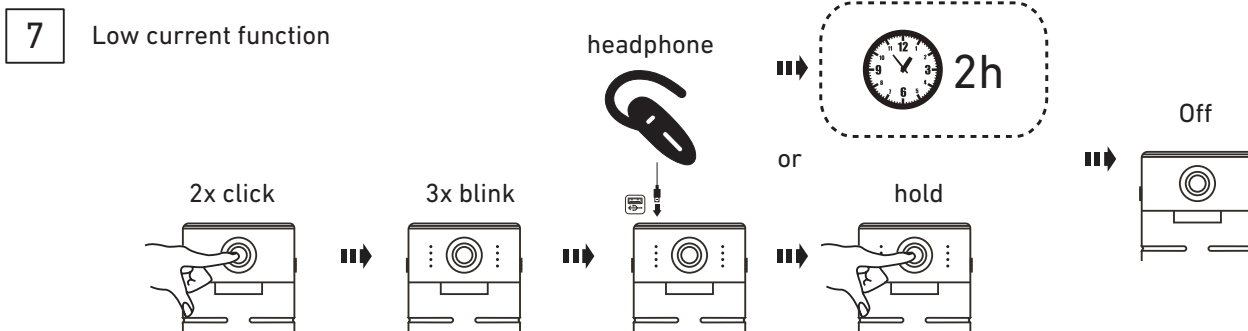
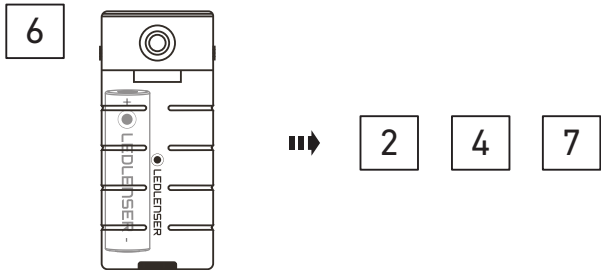

Ledlenser GmbH & Co. KG
 Kronenstr. 5-7 • 42699 Solingen • Germany
 Phone +49 212/5948-0 Fax +49 212/5948-200
 info@ledlenser.com



ledlenser.com



1J12A0328
 Flex 7 QUG_V0
 20190923